

SAFE ENSUITES

Designed for the toughest environments and manufactured using advanced technologies, safe-ensuite sanitaryware is robust yet designed to look domestic, making it ideal for therapeutic environments.



◀ VR01-013
High security WC pan
(with optional side infill available
left or right of pan)



VR01-001 ▲
VR01-004
High security basin and
optional backplate with
moulded shelf

Tested at the HMP test centre

The impressive range of DVS high security sanitaryware has been specially designed and developed for high security applications. Their design and construction are unique and unrivalled. The products have a gloss finish similar to that of porcelain, giving an attractive domestic look.

HIGH SECURITY SANITARYWARE

The techniques employed to construct these high security products are used very successfully in the field of ballistic armour.

Additional properties include high resistance to cyclical stresses and dual stage failure mode. This provides excellent impact resistance and will not be subject to catastrophic failure.

The surface of the product is a high-grade polyester gel coat specifically formulated for use with sanitaryware. It is formulated to produce high chemical resistance and resistance to ultraviolet effects.

Applications

DVS offer a range of ensuite packages, ensuring that you can select the perfect solution for your safe accommodation requirements.

The unique features suit high and low risk mental health units, prisons, police cells and other custodial applications.

THE PROBLEM

Conventional safe-ensuite sanitaryware can be broken and can shatter, producing dangerous shards of material for self harm or to harm others.

Conventional safe-ensuite sanitaryware is also extremely heavy, often needing 2 people to carry a single WC pan!

THE SOLUTION!

DVS high security sanitaryware has excellent impact resistance and will not shatter or produce dangerous shards of material.

As well as being very tough, the product is light with a toilet pan weighing less than 17kg!

Safety

The DVS high security sanitaryware range has been designed and tested to be vandal proof and avoid ligature points wherever possible.

The sanitaryware has been tested at HMP test centre at Lindholme. Unfortunately we cannot guarantee protection against those intent on self-harm, but consider that the designs and precautions taken are to a very high standard, reducing the risks significantly.



VR01-017 
Wall hung pan

Common features:

- ▶ Designed for high-security applications
- ▶ Virtually indestructible
- ▶ High impact resistance
- ▶ Anti-shatter moulded resin (avoiding the possibility of obtaining dangerous material, for self harm or to harm others)
- ▶ Home Office tested for anti-vandal, reduced-ligature and fire resistance
- ▶ Secure wall mount fixings (included)
- ▶ White sanitaryware grade gel coated finish
- ▶ Hygienic non-porous surface
- ▶ Attractive domestic look

DVS use ballistic armour manufacturing technologies for the production of a unique range of safe-ensuite sanitaryware.

The unique features suit high and low risk mental health units, prisons, police cells and other custodial applications.

WC PAN & EXTRAS



VR01-014 ⚡
High security WC pan
(with optional side infill available
left or right of pan)



VR01-017 ⚡
Wall hung pan



VR01-012 ⚡
Disabled WC pan white
enamelled steel spacer box
(for use with high security
disabled WC pan only)

WC Pan features:

- ▶ Concealed rear waste outlet
- ▶ Large trap to reduce blockages
- ▶ Optional facilities to lock-out water operations
- ▶ Optional side in-fills
- ▶ Optional disabled riser and spacer box

Wash Basin features:

- ▶ Rear concealed waste outlet
- ▶ Water thermostatically controllable
(using separate TMV3 valve - not supplied)
- ▶ Loose rubber plug (no chain, avoids ligature)
- ▶ In-built sensors (sold separately)
- ▶ In-built water spouts
- ▶ Moulded soap shelves
- ▶ Wave-on control (sold separately)
- ▶ Facilities to lock-out water operations
- ▶ Optional backplate with moulded shelf
- ▶ Spectrum backplate designed specifically to fit on
top of Twyford Spectrum wash basin

WASH BASIN & BACKPLATES



VR01-005 ⚡
High security basin
and backplate



VR01-001 ⚡
VR01-004
High security basin and
optional backplate with
moulded shelf



VR01-003 ⚡
Optional small backplate



VR01-023 ⚡
Spectrum backplate
(designed for Twyford Solo
Spectrum wash basin)

Mirror features:

- ▶ Moulded frame
- ▶ Virtually indestructible plastic mirror

Soap Dish features:

- ▶ Moulded soap outlet for easy cleaning
- ▶ Easy and secure method of fixing

No-Touch Wave-On Sensor features:

- ▶ Extremely reliable
- ▶ Reduced-ligature
- ▶ Vandal resistant

High Security Deck Mount Tap features:

- ▶ Extremely reliable
- ▶ Reduced-ligature
- ▶ Vandal resistant

OTHER/ACCESSORIES



VR01-025 ⚡
High security mirror

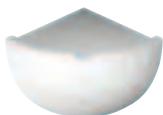

VR01-026 ⚡
High security corner
soap dish



AT07-056 ⚡
High security deck
mounted spout, brushed



VR02-001 ⚡
Hand rinse



VR02-002 ⚡
Urinal

WASHROOM CONTROL SYSTEMS

The Washroom Control System has been specially designed to meet the requirements of the modern day safe-ensuite in mental health units, prisons and police cells.

Dart Valley Systems also offer individual controls for taps, showers or WC flushing, however the Washroom Control System offers an outstanding value for money all encompassing control package.

Capable of managing:

- ▶ DVS WC Flushvalve
- ▶ Shower control
- ▶ Call-out button for manual or computer interfacing
- ▶ Hot and cold tap control (ideal for controlling the DVS high security backplate with in-built water spouts)
- ▶ All of the above controls have the built in option of 'Lock-Out', to limit the amount of operations in each period of adjustable run times

Features include:

- ▶ Multi-function unit from one control
- ▶ Variable functions allowing custom setups to suit individual requirements
- ▶ Optional reset or lock-out feature from a keyswitch controlled pad
- ▶ Lock-outs (selectable)
- ▶ Optional call-out button
- ▶ Can be integrated to monitor water usage and number of times used
- ▶ Covers a variety of uses (reduces installation and unit cost dramatically)
- ▶ Purge facility

Major clients include:

- ▶ Interserve
- ▶ Laing O'Rourke
- ▶ Crown House Technologies
- ▶ WH Foster
- ▶ Bushboard
- ▶ St Andrews Healthcare
- ▶ Off Site Solutions
- ▶ Cumbria Partnership NHS Foundation
- ▶ Venesta Washrooms
- ▶ Care Principles Ltd



VR07-002 ▲
Washroom Control System

The DVS Washroom Control System is capable of managing WC flushing, shower control, and a wash basin with two tap spouts.



AC02-040 ◀◀



AC02-041 ◀◀
Anti-Vandal Sensors



AT07-001 ◀◀
Tap Control System

Tap Control System

The tap control system can be used to control mixed water for 1 or 2 taps, or to control both hot and cold on a single tap using 2 sensors. The control system can be used with wave-on or tactile sensors. The tap control system also features built-in purge control option to avoid stagnation.

When a user waves their hand past the sensor (or pushes the tactile switch) the control system activates the solenoid valve. The valve will then run for a pre-set time before automatically closing the valve and stopping the tap.

Various settings can be customised quickly and easily from within the control box if necessary.

Features include:

- ▶ Saves water, switches off after pre-set time
- ▶ No-touch - Helps avoid cross infection
- ▶ High performance & reliability
- ▶ Adjustable run-time
- ▶ Settings allow option to 'wave-off'

A range of safe ensuite packages make selecting the right products simple, including high risk and low risk options.

COMPLETE ENSUITE PACKAGES

There are two categories to consider:

- ▶ High risk (includes unbreakable sanitaryware)
- ▶ Low risk (includes Twyford ceramic sanitaryware with DVS backplate)

Standard DVS ensuite products are designed and tested for the high risk category and are proposed for these areas.

Safety

Dart Valley Systems' high security safe-ensuite products have been designed and tested to be vandal proof and avoid ligature points wherever possible.

The sanitaryware has been tested at HMP test centre at Lindholme. Unfortunately we cannot guarantee protection against those intent on self-harm, but consider that the designs and precautions taken are to a very high standard, reducing the risks.

Features include:

- ▶ Designed to avoid ligature points
- ▶ Products designed to be vandal proof
- ▶ Reduces the possibility of patients obtaining dangerous material, for self harm or to harm others
- ▶ Water is thermostatically controlled
- ▶ Facilities to 'lock-out' water operations
- ▶ Easy to use
- ▶ Aesthetically attractive

Package Categories

There are two packages available for each category. Both categories offer suites with and without shower facilities.

High Risk Ensuite

The 'High Risk' category includes DVS unbreakable sanitaryware to increase the overall security of the ensuite. This sanitaryware has been specially designed for high security applications with several safety advantages over standard sanitaryware.

Low Risk Ensuite

Some Trusts may consider that low risk areas do not require specialist unbreakable sanitary ware. Twyford ceramic Spectrum basins and Galerie WC pans are therefore proposed for these areas.

An alternative high security backplate specially designed for the Twyford Spectrum basin is also part of the 'Low Risk' ensuite.

In every other respect the 'High Risk' and 'Low Risk' safe ensuite are to the same specification. This means that the operation, technology, products and maintenance are standard throughout.

Sensor Options

There are two options for operating the shower and WC Flushvalve. Both are vandal proof and virtually ligature free.

Most installations use the wave-on sensor but some prefer the push button tactile switch to reduce the risk of accidentally turning on the shower.

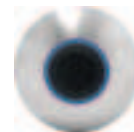

AC02-040 
Anti-vandal wave-on sensor with 50mm chrome bezel for WC



AC02-046 
Tactile switch with 50mm steel bezel



SH00-011 
Ligature Resistant Blending Valve

HIGH RISK ENSUITE PACKAGES

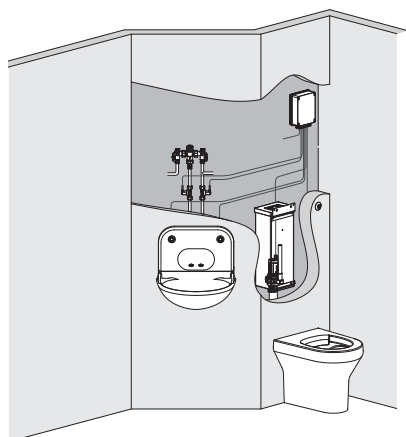

« Package 1 -
High Risk excl. shower

Package 1 includes:

- 1 x Washroom control system
- 1 x TMV3 Thermostatic mixing valve
- 2 x Solenoid valves
- 1 x High security backplate
- 1 x High security basin
- 1 x WC Anti-vandal wave-on sensor
- 1 x WC Flushvalve
- 1 x Concealed cistern kit
- 1 x High security WC pan

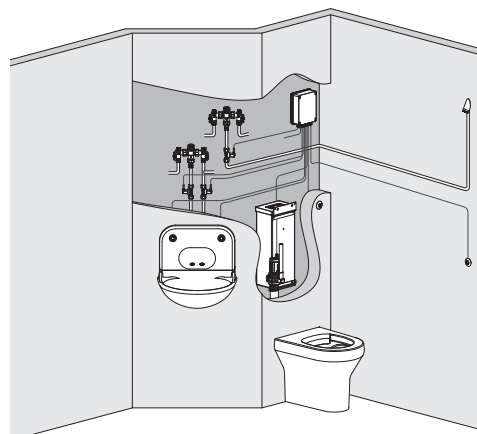

« Package 2 -
High Risk incl. shower

Package 2 includes:

- All of Package 1 plus:
- 1 x Shower sensor for showerhead
 - 1 x Anti-ligature showerhead
 - 1 x Additional TMV3 mixing valve
 - 1 x Additional solenoid valve

LOW RISK ENSUITE PACKAGES

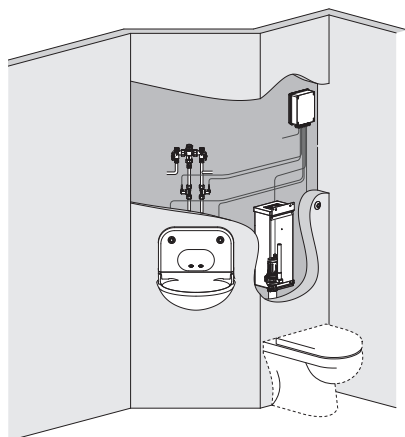

« Package 3 -
Low Risk excl. shower

Package 3 includes:

- 1 x Washroom control system
- 1 x TMV3 Thermostatic mixing valve
- 2 x Solenoid valves
- 1 x High security backplate
- 1 x High security basin
- 1 x WC Anti-vandal wave-on sensor
- 1 x WC Flushvalve
- 1 x Concealed cistern kit
- 1 x Twyford Galerie ceramic WC pan

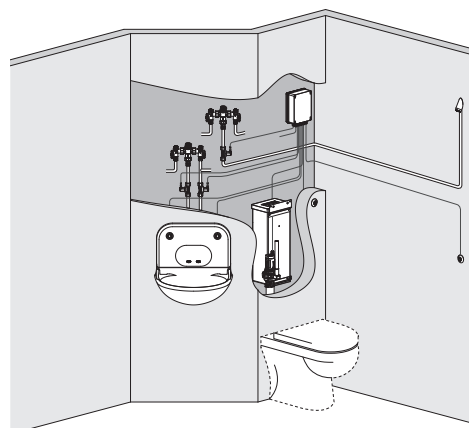

« Package 4 -
Low Risk incl. shower

Package 4 includes:

- All of Package 3 plus:
- 1 x Shower sensor for showerhead
 - 1 x Anti-ligature showerhead
 - 1 x Additional TMV3 mixing valve
 - 1 x Additional solenoid valve

⊘ Dashed Outline = Low Risk Twyford Sanitaryware

⚠ **Fixing Notes:** All packages come complete with 70mm fixing kits. For other options please call our customer service team.

Typical installation diagrams are intended as a guide only. Appropriate regulations should be adhered to.

Dimensions

HIGH SECURITY SANITARYWARE

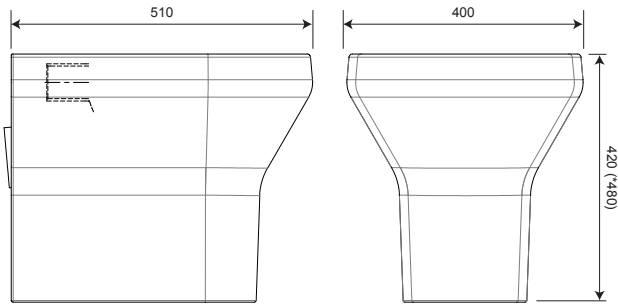

VR01-010 - High security WC pan [↗](#)

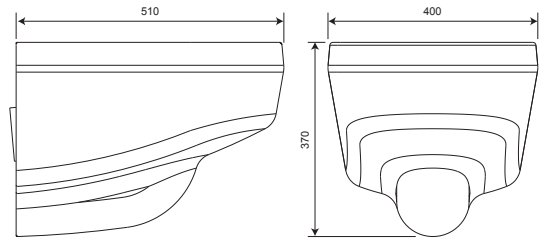

VR01-017 - High security Wall Hung Pan [↗](#)

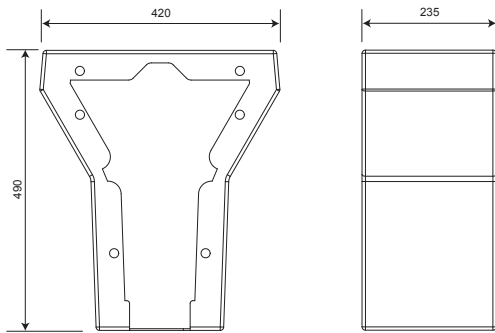

VR01-012 [↗](#)
Disabled WC pan white enameled steel spacer box
(for use with high security disabled WC pan only)

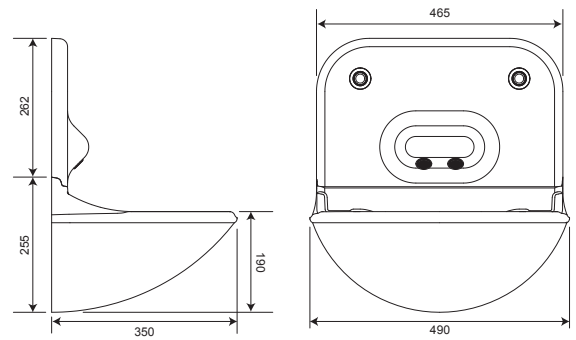

VR01-005 [↗](#)
High security basin and backplate

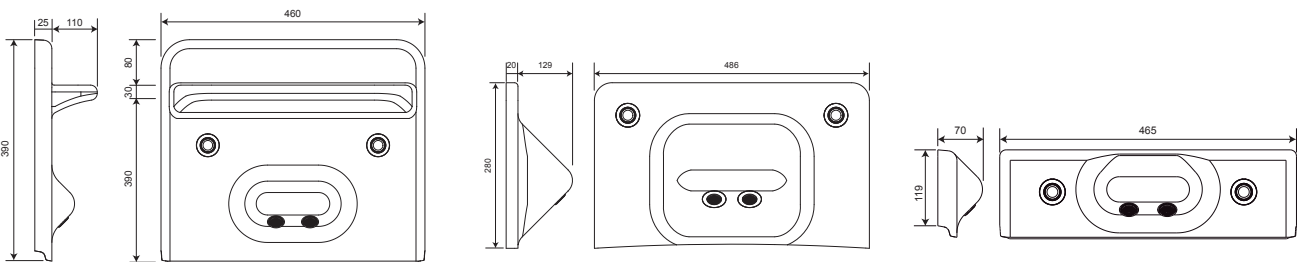

VR01-004 [↗](#)
High security backplate with shelf

VR01-023 [↗](#)
High security backplate for Spectrum basin

VR01-003 [↗](#)
High security backplate for Spectrum basin

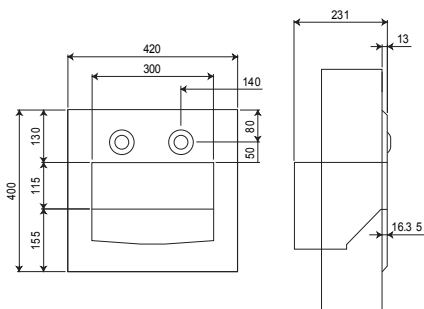

VR02-001 [↗](#)
Electric Handrinse

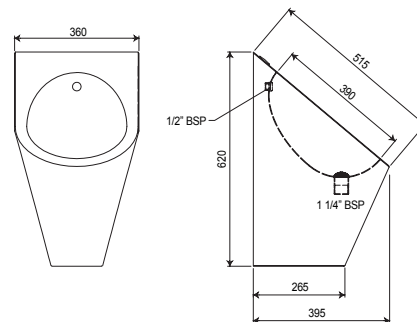

VR02-002 [↗](#)
Urinal Bowl

Please note: Illustrations not to scale

Dimensions

LOW SECURITY SANITARYWARE

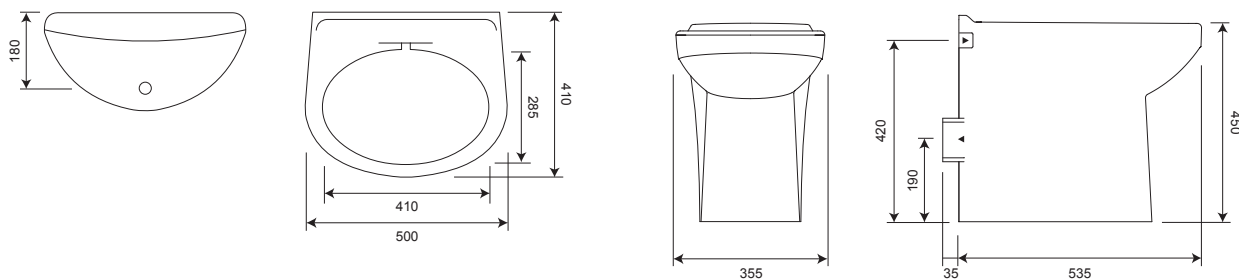

SW00-009

Sola Spectrum 500 - Washbasin (available with no tap holes only)

SW00-002

Avalon - Rimless BTW WC pan

CONTROL SYSTEMS AND SENSORS

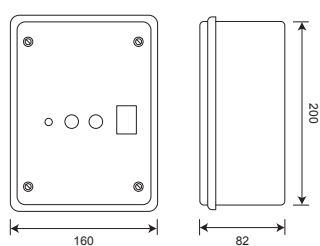

VR07-002

Washroom control system

Mains cable length: 1.5m

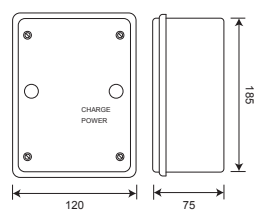

WC00-010

Control box (PCB) for prison flushvalves

Mains cable length: 1.5m

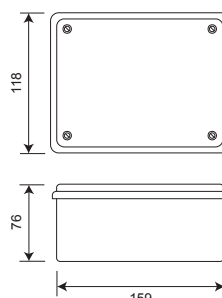

AT07-001

Tap control system - Mains

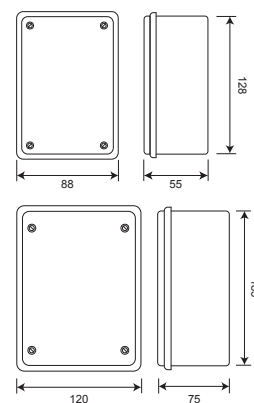

AT07-002 (Top)
AT07-003 (Bottom)

2 Channel tap control box - Battery

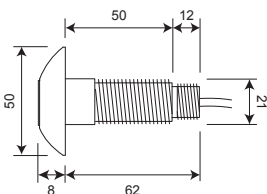

AC00-040 (blue insert)
AC00-041 (red insert)

Anti-vandal wave-on sensor with 50mmø bezel

Cable length: 3m

Fixing: 1/2" BSP
Fixing for extension: 3/8" BSP
(22mmø clearance drill hole)

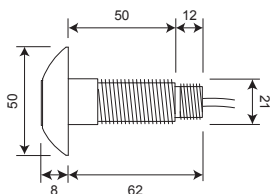

AC00-046 (blue insert)
AC00-047 (red insert)

Tactile switch with 50mmø bezel

Cable length: 3m

Fixing: 1/2" BSP
Fixing for extension: 3/8" BSP
(22mmø clearance drill hole)

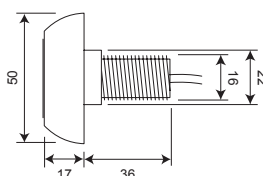

SH00-001

Wave-on sensor with 50mmø bezel

Cable length: 8m

Fixing: 3/8" BSP
(22mmø clearance drill hole)

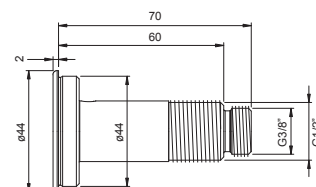

VR00-001

Wave-on sensor for backplates with Blue insert (C) 3m cable

VR00-002

Wave-on sensor for backplates with Red insert - (H) 3m cable

Please note: Illustrations not to scale

Dimensions

WC FLUSHING AND OTHER ACCESSORIES

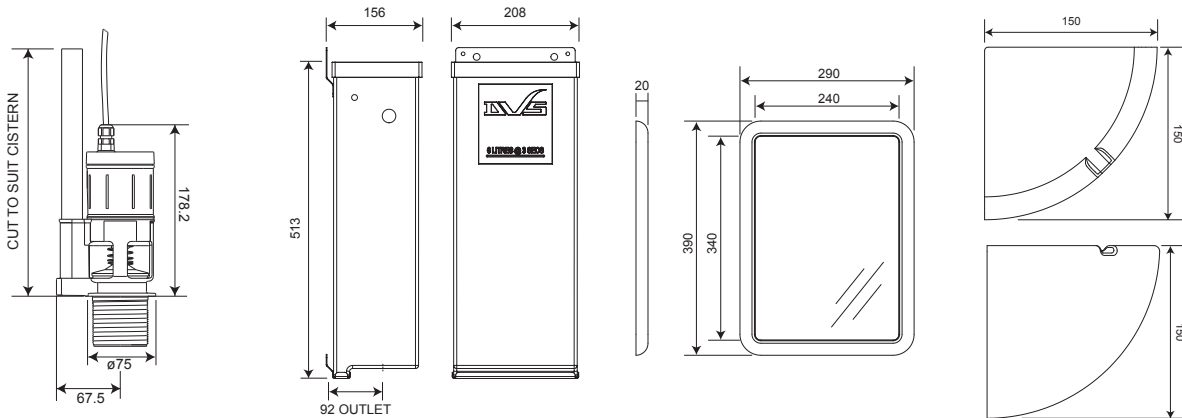

WC01-023 ⚡

WC Flushvalve

Cable length: 3m

Fixing: Standard 1 1/2" (2" available)

WC02-004 ⚡

Concealed plastic cistern - Vertical

VR01-025 ⚡

High security mirror

VR01-026 ⚡

Corner high security soap dish

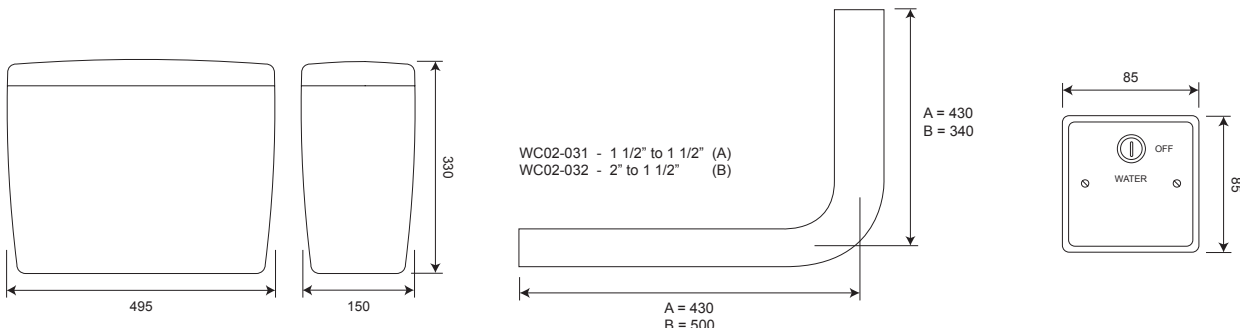

WC02-001 ⚡

Concealed plastic cistern

WC02-031 (A) / WC02-032 (B) ⚡

Flushpipes

AC04-016 ⚡

Water control key switch for washroom control box

Fixing: Screw fix

SHOWERHEADS AND NOSSLES

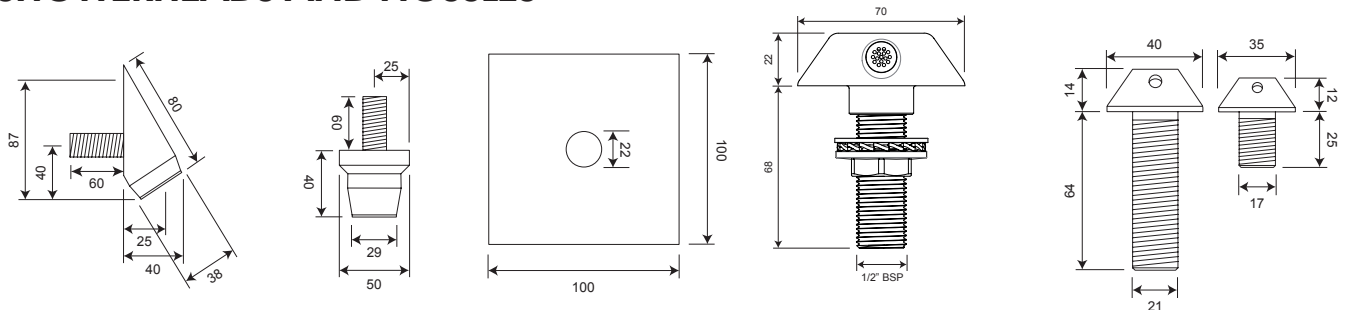

SH07-040 ⚡

30° High security WM showerhead

Fixing: 1/2" BSP
(22mmø clearance drill hole)

SH07-042 ⚡

Ceiling mounted high security showerhead

Fixing: 1/2" BSP
(22mmø clearance drill hole)

SH07-052 ⚡

Fixing plate for ceiling mounted high security showerhead

AT07-056 ⚡

High security deck mounted spout

AT07-055 and AT07-054 ⚡

High security stainless steel tap nozzles. Basin mounted (left) or stainless steel mounted (right)

D629 Fixing: 1/2" BSP
D629/SS Fixing: 3/8" BSP
Extension Fixing: 1/2" BSP







Please note: Illustrations not to scale

SAFE ENSUITES

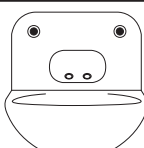
Individual Safe Ensuite Products

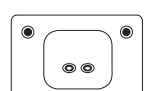
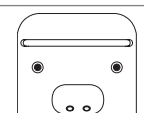
△ **Please Note:** Fixing kits for high security sanitaryware and extensions for showerheads and sensors need to be specified below separately, due to possible variations in wall thicknesses across installation locations.

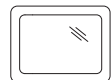
Sanitaryware

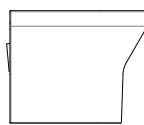

Profile (Not to scale)	Code	Description
	VR01-005	High security basin and backplate (not including sensors)
	VR01-001	High security basin only (without backplate)
	VR01-027	Replacement rubber bung/plug for filling basin
	VR01-028	Waste grid (complete with stubbed pipe to hold in position)
		△ Notes: Moulded soap shelves. Rear waste outlet. No overflow. Not including sensors. Includes 70mm fixing kit. Water spouts included. Push or wave-on sensors available.
	VR01-002	High security backplate (not including sensors)
		△ Notes: For use with VR01-001 high security basin only. Not including sensors. Includes 70mm fixing kit. Water spouts included. Push or wave-on sensors available.
	VR01-003	High security backplate (not including sensors)
		△ Notes: For use with VR01-001 high security basin only. Not including sensors. Includes 70mm fixing kit. Water spouts included. Push or wave-on sensors available.
	VR01-023	High-security basin filling backplate (not including sensors)
	VR01-024	High-security bath filling backplate (not including sensors)
		△ Notes: Not including sensors. Includes 70mm fixing kit. Water spouts included. Push or wave-on sensors available.
	VR01-004	Extended high security backplate with moulded shelf (not including sensors)
		△ Notes: For use with VR01-001 high security basin only. Not including sensors. Includes 70mm fixing kit. Water spouts included. Push or wave-on sensors available.
	VR01-002	Wave-on sensor for backplates with Red insert (Hot) - Cable length 3m
	VR01-001	Wave-on sensor for backplates with Blue insert (Cold) - Cable length 3m
	VR01-006	Push sensor for backplates with Red insert (Hot) - Cable length 3m
	VR01-005	Push sensor for backplates with Blue insert (Cold) - Cable length 3m
	VR01-009	Basin/backplate fixing kit for 100mm wall thickness
	VR01-007	Basin/backplate fixing kit for 150mm wall thickness
	VR01-008	Basin/backplate fixing kit for 250mm wall thickness
		△ Notes: The above fixing kits contain all fixings required for basin, sensors and water inlets.
	VR01-025	High security mirror with white moulded frame
	VR00-010	Structural adhesive for securing mirrors and soap dishes
		△ Notes: Unbreakable mirror. Matches other high security sanitaryware product range.
	VR01-026	High security soap dish
	VR00-010	Structural adhesive for securing mirrors and soap dishes
	VR01-010	High security WC pan
	VR01-011	Disabled high security WC pan (60mm higher)
	VR01-013	High security WC pan side in-fill c/w- Left side
	VR01-014	High security WC pan side in-fill c/w- Right side
	VR01-012	Disabled WC pan white enameled steel spacer box
	VR01-022	WC pan fixing kit for 70mm wall thickness
	VR01-019	WC pan fixing kit for 100mm wall thickness (standard supplied with WC pan)
	VR01-020	WC pan fixing kit for 150mm wall thickness
	VR01-021	WC pan fixing kit for 250mm wall thickness
	VR01-016	WC Seat retrofit kit option
	VR01-015	High security WC Pan c/w WC seat pre-fitted
		△ Notes: The above fixing kits contain all fixings required for WC pan.

SAFE ENSUITES







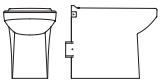



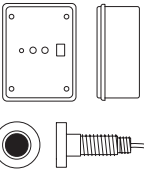



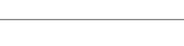

Ceramics

All the ceramics shown are vitreous china built to BS 3402 standards.

Sanitaryware (continued)



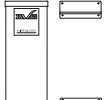

Profile (Not to scale)	Code	Description
	VR01-017	High security wall hung pan
	SW00-009 SW00-010	Twyford Sola Spectrum 500 - Washbasin with no tap holes Twyford Sola Spectrum 500 - Basin fitting kit △ Notes: Very low risk option.
	SW00-002 SW00-001	Twyford Avalon - Rimless Back-to-wall (BTW) WC pan Twyford Avalon - Seat and cover (or rim only) - Various seat covers available △ Notes: Very low risk option. Washdown action with box flushing rim. Horizontal outlet. Fully concealed plumbing.

Control Systems, Sensors and WC Flushing

Profile (Not to scale)	Code	Description
	VR07-004 VR07-003 VR07-002 AT07-001 AC17-009 PP00-100 PP00-101 PP00-102	Standard washroom control system kit - For use with DVS high security backplates 2" Washroom control system kit - Domed Head sensor when backplates are not used 2" Washroom control system - Control box only Tap control system for 1 or 2 taps (control box only) Plastic valve (12v DC) with 3m cable and spade connectors Tap control system fuse - Primary - 20mm Glass 240V (T)100mA Tap control system fuse - Secondary - TR5 (F)500mA Replacement fuse for washroom control system - 20mm Glass (T) 125mA △ Notes: Standard kit includes 1 x Control box, 1 x WC Flushvalve, 3 x Wave-on sensors (1 for WC, 2 for basin), 2 x Solenoid valves for tap control plus connection wires @ 3m. The kit does not include a sensor for shower operation.
	SH00-001 (A)	Wave-on shower sensor with 50mmø chrome bezel - Cable length 8m
	AC00-041 (B)	Anti-vandal wave-on WC sensor with 50mmø stainless steel bezel - red insert - Cable length 3m
	AC00-040 (B)	Anti-vandal wave-on WC sensor with 50mmø stainless steel bezel - blue insert - Cable length 3m
	AC00-047 (C)	Tactile switch with 50mmø stainless steel bezel and red insert (Hot) - Cable length 3m
	AC00-046 (C)	Tactile switch with 50mmø stainless steel bezel and blue insert (Cold) - Cable length 3m
	SH00-002	Wave-on shower sensor with 50mm bezel - Cable length 15m
	AC02-043	Anti-vandal wave-on sensor c/w Blue indication insert & 50mm 15mtr
	AC02-044	Anti-vandal wave-on sensor c/w Red indication insert & 50mm 15mtr
	AC02-049	Tactile switch with 50mm st/steel bezel and Blue insert C 15mtr
	AC02-050	Tactile switch with 50mm st/steel bezel and Red insert H 15mtr
	VR00-001 (D)	Wave-on sensor for backplates with Blue insert (C) 3m cable
	VR00-003 (D)	Wave-on sensor for backplates with Blue insert (C) 15m cable
	VR00-004 (D)	Wave-on sensor for backplates with Red insert (H) 15m cable
	VR00-007 (D)	Push sensor for backplates with Blue insert (C) 15m cable
	VR00-008 (D)	Push sensor for backplates with Red insert (H) 15m cable △ Notes: Includes bezels. All suitable for use with the washroom control system.
	AC02-056 AC02-057 AC02-058	Sensor thread extension for 100mm wall thickness Sensor thread extension for 150mm wall thickness Sensor thread extension for 250mm wall thickness
	WC01-023	Flushvalve with in-built overflow (valve only) - 2" base
	WC02-014	Concealed Plastic Cistern - Vertical - 2 kit △ Notes: Kit Includes cistern, fixing plates, torbeck valve, flushpipe and fittings for back of pan.

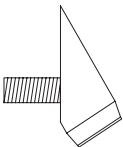
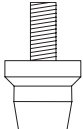
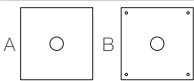
SAFE ENSUITES

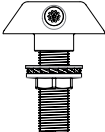
Showerheads and Accessories

Profile (Not to scale)	Code	Description
	SH07-040 SH00-021	High security showerhead - 30° (80mm long from top) Replacement loose white rings for the above showerheads △ Notes: Wall mounted. Substantially reduced ligature risk. Standard finish is brushed stainless steel. Polished finish also available. High security showerheads come standard with 60mm 1/2" BSP fixing thread.
	SH07-042 SH00-021	High security showerhead - Ceiling mounted Replacement loose white rings for the above showerheads △ Notes: Ceiling mounted. Substantially reduced ligature risk. Standard finish is brushed stainless steel. Polished finish also available. High security showerheads come standard with 60mm 1/2" BSP fixing thread.
	SH07-052 (A) SH07-041 (B)	Backplate for securing SH07-042 ceiling mounted showerhead Square fixing plate suitable for SH07-042, shower sensor and blending valve adjuster △ Notes: Standard finish is brushed stainless steel.
	AT07-055	High security tap nosse - Basin mounted △ Notes: Standard finish is brushed stainless steel. 1/2" BSP.
	AT07-054	High security tap nosse - Stainless steel mounted △ Notes: Standard finish is brushed stainless steel. 3/8" BSP.
	AT07-056 AT07-057	High security deck mounted spout - Brushed High security deck mounted spout - Polished
	AC04-018 AC04-019 AC04-017 AC04-016	Water control key switch kit - 12v DC* Water control key switch kit - Two valve - 12v DC* Water control key switch kit for 2 channel Water control key switch (with 5m cable)** *For water isolation. Includes PSU, 15mm plastic valve(s) and leads. **Suitable for use with the washroom control system for isolating water or resetting lockouts.

Anti-Pick Sealant

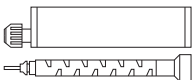
Profile (Not to scale)	Code	Description
	VR00-012	Heavy duty anti-pick sealant with nosse - In White - 250ml (uses standard gun)
	VR00-013	Replacement nosse for anti-pick sealant
	VR00-010	Structural adhesive for mirrors
	VR00-011	Special twin gun (only required for structural adhesive) △ Notes: Specially formulated "white" anti-pick sealant for custodial applications. Can be applied using standard heavy duty sealant guns. The special nosse combines the two part sealant which is incredibly tough, adheres to most surfaces and cures in approx 3-4 hours.

SAFE ENSUITES

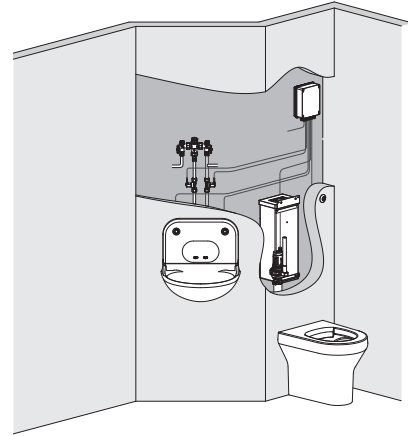

Ensuite Package 1 - High Risk (excl. shower)

Ensuite package 1 includes all of the individual items listed below except non-standard fixing lengths and optional extras. If longer fixing threads are required please specify. Fixing threads are available for 150mm, 200mm and 300mm wall thickness.

Ensuite Package 1 - High Risk (excl. shower)

Description

Complete ensuite package 1 - High Risk (excluding shower) - Standard

Package Breakdown - Individual Items

Code	Description
VR01-010	High security WC pan
VR01-005	High security basin and backplate kit with in-built spouts (warm and cold water)
VR01-007	Standard washroom control system kit - For use with DVS high security backplates
WC02-014	Concealed tall cistern kit (2")
AC17-047	DVS thermostatic mixing valve (for basin)

Fixings and Extensions (Not included in the standard package)

Code	Description
VR01-019	WC pan fixing kit for 100mm wall thickness (standard supplied with WC pan)
VR01-020	WC pan fixing kit for 150mm wall thickness
VR01-021	WC pan fixing kit for 250mm wall thickness
VR01-006	Basin/backplate fixing kit for 100mm wall thickness
VR01-007	Basin/backplate fixing kit for 150mm wall thickness
VR01-008	Basin/backplate fixing kit for 250mm wall thickness
AC02-056	Sensor thread extension for 100mm wall thickness (for WC sensor)
AC02-057	Sensor thread extension for 150mm wall thickness (for WC sensor)
AC02-058	Sensor thread extension for 250mm wall thickness (for WC sensor)

△ **Notes:** When ordering sensor extensions please specify for use with WC sensor.

Options

Code	Description
VR01-013	High security WC pan side in-fill - Left side
VR01-014	High security WC pan side in-fill - Right side
VR01-011	Disabled high security WC pan (60mm higher)
VR01-012	Disabled WC pan white enameled steel spacer box
VR01-004	Extended high security backplate with moulded shelf (not including sensors)
VR01-025	High security mirror with white moulded frame
AC04-016	Key switch for re-setting lock-outs (for Washroom Control System)

SAFE ENSUITES

Ensuite Package 2 - High Risk (incl. shower)

Ensuite package 2 includes all of the individual items listed below except non-standard fixing lengths and optional extras. If longer fixing threads are required please specify. Fixing threads are available for 150mm, 200mm and 300mm wall thickness.

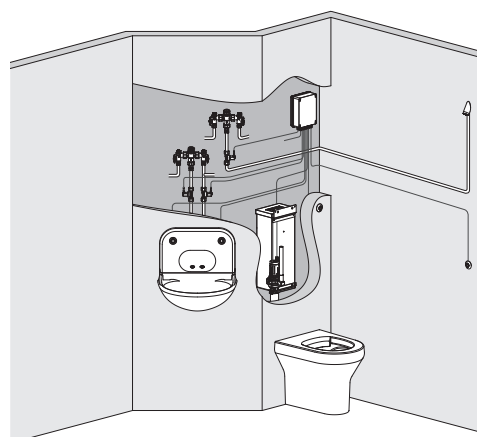

⚠ **Please Note:** Fixing extensions for showerhead and sensor need to be specified below separately due to possible variations in wall thicknesses across installation locations.

Ensuite Package 2 - High Risk (incl. shower)

Description

Complete ensuite package 2 - High Risk (including shower) - Standard

Package Breakdown - Individual Items

Code	Description
VR01-010	High security WC pan
VR01-005	High security basin and backplate kit with in-built spouts (warm and cold water)
VR01-007	Standard washroom control system kit - For use with DVS high security backplates
WC02-014	Concealed tall cistern kit (2")
AC17-047	DVS thermostatic mixing valve x 2 (1 for basin and 1 for showerhead)
SH07-040	Anti-ligature showerhead
SH00-001	Anti-vandal shower sensor for showerhead
AC17-009	Solenoid valve for showerhead

Fixings and Extensions (Not included in the standard package)

Code	Description
VR01-019	WC pan fixing kit for 100mm wall thickness (standard supplied with WC pan)
VR01-020	WC pan fixing kit for 150mm wall thickness
VR01-021	WC pan fixing kit for 250mm wall thickness
VR01-006	Basin/backplate fixing kit for 100mm wall thickness
VR01-007	Basin/backplate fixing kit for 150mm wall thickness
VR01-008	Basin/backplate fixing kit for 250mm wall thickness
AC02-056	Sensor thread extension for 100mm wall thickness (for WC sensor, showerhead or shower sensor)
AC02-057	Sensor thread extension for 150mm wall thickness (for WC sensor, showerhead or shower sensor)
AC02-058	Sensor thread extension for 250mm wall thickness (for WC sensor, showerhead or shower sensor)

⚠ **Notes:** When ordering sensor extensions please specify for use with WC sensor.

Options

Code	Description
VR01-013	High security WC pan side in-fill - Left side
VR01-014	High security WC pan side in-fill - Right side
VR01-011	Disabled high security WC pan (60mm higher)
VR01-012	Disabled WC pan white enameled steel spacer box
VR01-004	Extended high security backplate with moulded shelf (not including sensors)
VR01-025	High security mirror with white moulded frame
VR01-042	High security ceiling showerhead
SH00-011	Showerhead temperature blending valve
AC04-016	Key switch for re-setting lock-outs (for Washroom Control System)

SAFE ENSUITES

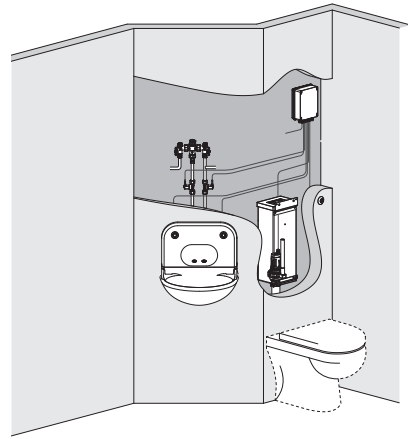

Ensuite Package 3 - Low Risk (excl. shower)

Ensuite package 3 includes all of the individual items listed below except non-standard fixing lengths and optional extras.

If longer fixing threads are required please specify. Fixing threads are available for 150mm, 200mm and 300mm wall thickness.

Ensuite Package 3 - Low Risk (excl. shower)

Description

Complete ensuite package 3 - Low Risk (excluding shower) - Standard

▲ **Notes:** Includes standard fixing kits suitable for IPS panels. Excludes optional extras.

Package Breakdown - Individual Items

Code	Description
SW00-002	Twyford Avalon ceramic WC pan (Includes fixings)
SW00-001	Twyford Avalon - Seat and cover only
VR01-005	High security basin and backplate kit with in-built spouts (warm and cold water)
VR07-007	Standard washroom control system kit - For use with DVS high security backplates
WC02-014	Concealed tall cistern kit (2")
AC17-047	DVS thermostatic mixing valve (for basin)

Fixings and Extensions (Not included in the standard package)

Code	Description
VR01-006	Basin/backplate fixing kit for 100mm wall thickness
VR01-007	Basin/backplate fixing kit for 150mm wall thickness
VR01-008	Basin/backplate fixing kit for 250mm wall thickness
AC02-056	Sensor thread extension for 100mm wall thickness (for WC sensor)
AC02-057	Sensor thread extension for 150mm wall thickness (for WC sensor)
AC02-058	Sensor thread extension for 250mm wall thickness (for WC sensor)

▲ **Notes:** When ordering sensor extensions please specify for use with WC sensor.

Options

Code	Description
VR01-025	High security mirror with white moulded frame
AC04-016	Key switch for re-setting lock-outs (for Washroom Control System)

 Dashed Outline = Low Risk Twyford Sanitaryware

SAFE ENSUITES

Ensuite Package 4 - Low Risk (incl. shower)

Ensuite package 4 includes all of the individual items listed below except non-standard fixing lengths and optional extras.

If longer fixing threads are required please specify. Fixing threads are available for 150mm, 200mm and 300mm wall thickness.

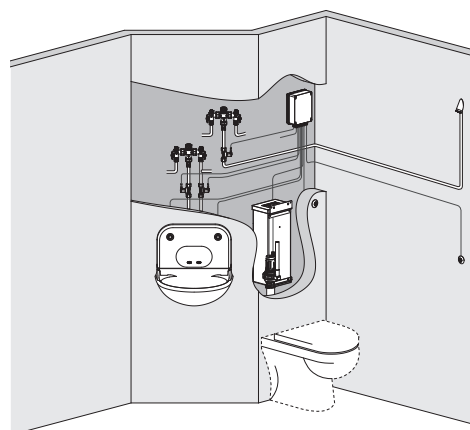

⚠ **Please Note:** Fixing extensions for showerhead and sensor need to be specified below separately due to possible variations in wall thicknesses across installation locations.

Ensuite Package 4 - Low Risk (incl. shower)

Description

Complete ensuite package 4 - Low Risk (including shower) - Standard

⚠ **Notes:** Includes standard fixing kits suitable for IPS panels. Excludes optional extras.

Package Breakdown - Individual Items

Code	Description
SW00-002	Twyford Avalon ceramic WC pan (Includes fixings)
SW00-001	Twyford Avalon - Seat and cover only
VR01-005	High security basin and backplate kit with in-built spouts (warm and cold water)
VR07-004	Standard washroom control system kit - For use with DVS high security backplates
WC02-014	Concealed tall cistern kit (2")
AC17-047	DVS thermostatic mixing valve x 2 (1 for basin and 1 for showerhead)
SH07-040	Anti-ligature showerhead
SH00-001	Anti-vandal shower sensor for showerhead
AC17-009	Solenoid valve for showerhead

Fixings and Extensions (Not included in the standard package)

Code	Description
VR01-006	Basin/backplate fixing kit for 100mm wall thickness
VR01-007	Basin/backplate fixing kit for 150mm wall thickness
VR01-008	Basin/backplate fixing kit for 250mm wall thickness
AC02-056	Sensor thread extension for 100mm wall thickness (for WC sensor, showerhead or shower sensor)
AC02-057	Sensor thread extension for 150mm wall thickness (for WC sensor, showerhead or shower sensor)
AC02-058	Sensor thread extension for 250mm wall thickness (for WC sensor, showerhead or shower sensor)

⚠ **Notes:** When ordering sensor extensions please specify for use with WC sensor.

Options

Code	Description
VR01-025	High security mirror with white moulded frame
SH07-042	High security ceiling showerhead
SH00-011	Showerhead temperature blending valve
AC04-016	Key switch for re-setting lock-outs (for Washroom Control System)

 Dashed Outline = Low Risk Twyford Sanitaryware